



Alumil



Alumil
➤ INDOORS

Linear Doors

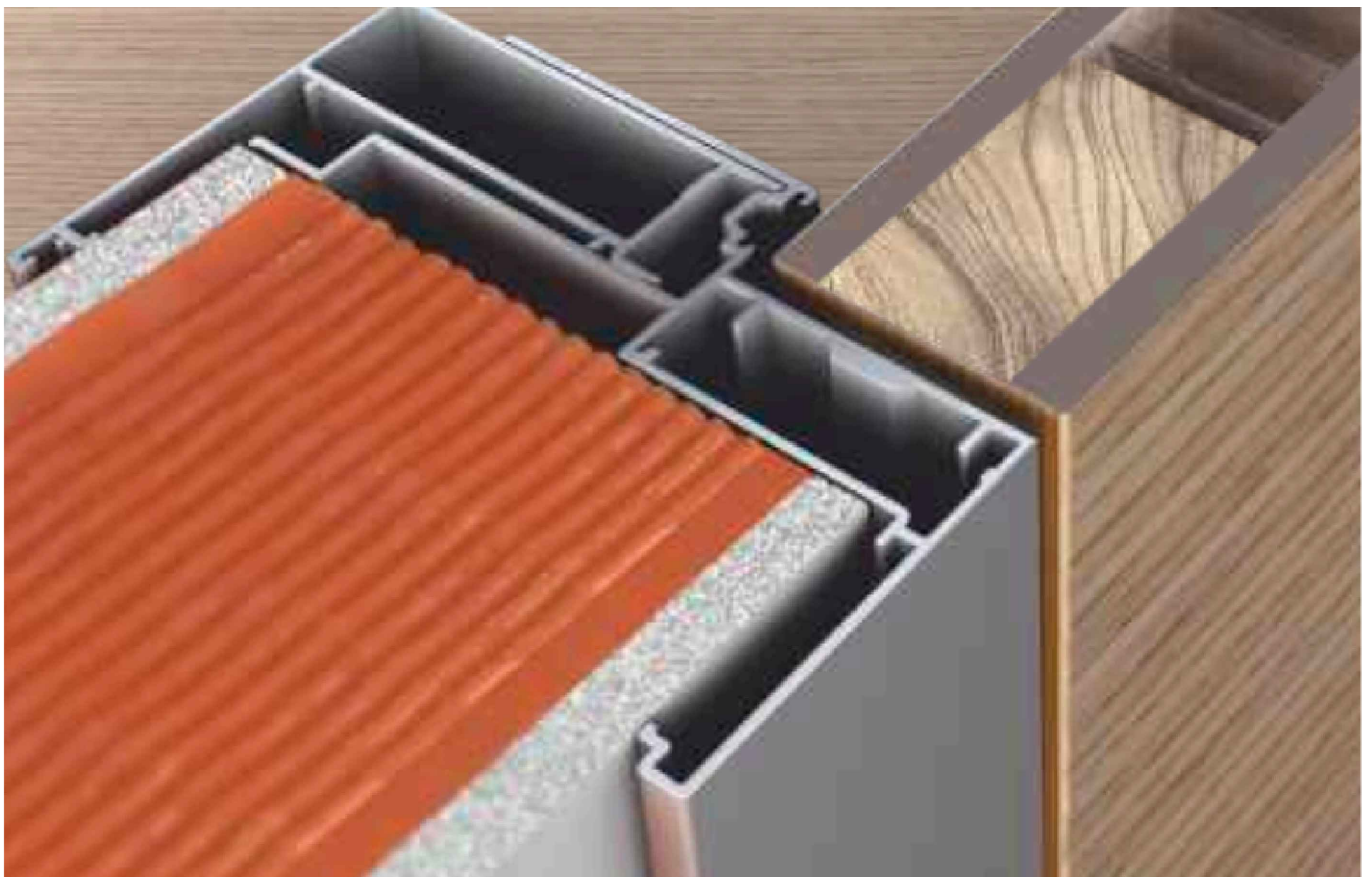

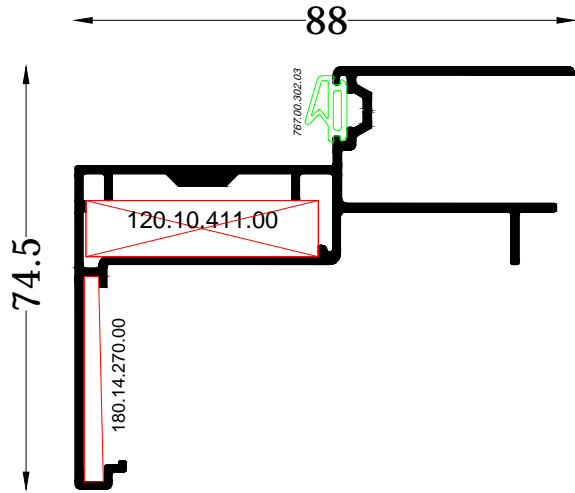

M0194 Linear frame for wooden panel sash 42mm

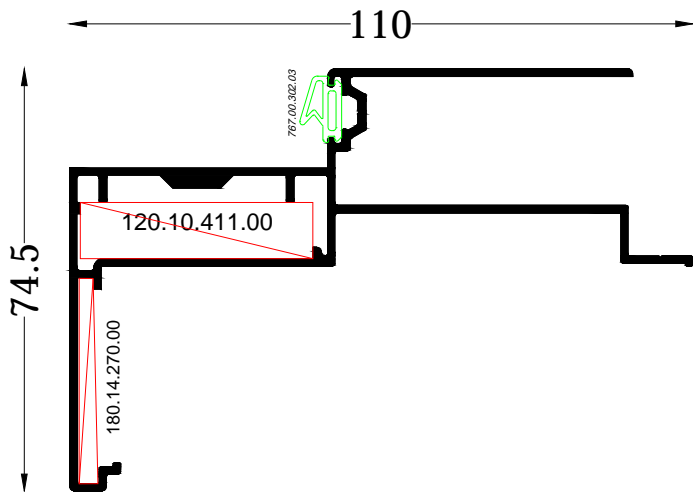

M0192 Linear frame for wooden panel sash 42mm

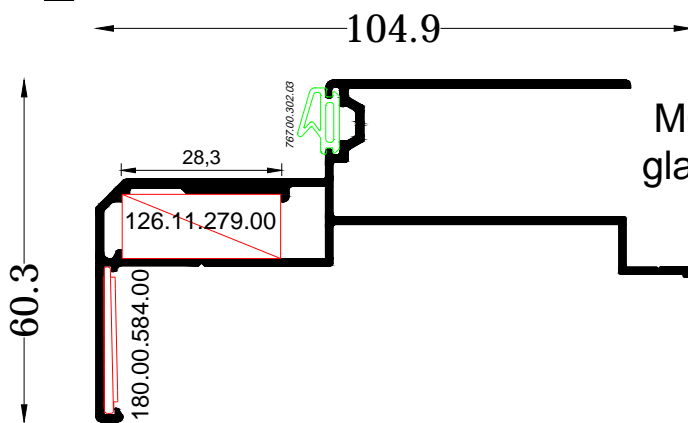

M0166 Linear frame for glass panel sash 10mm

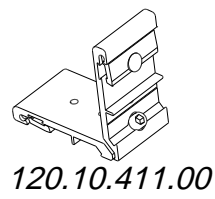
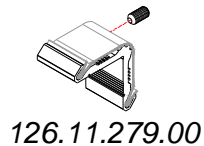

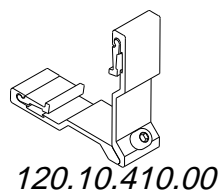
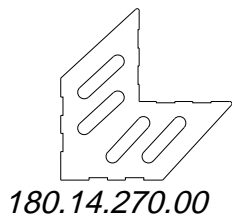
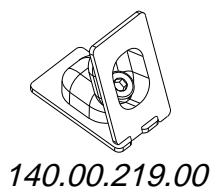
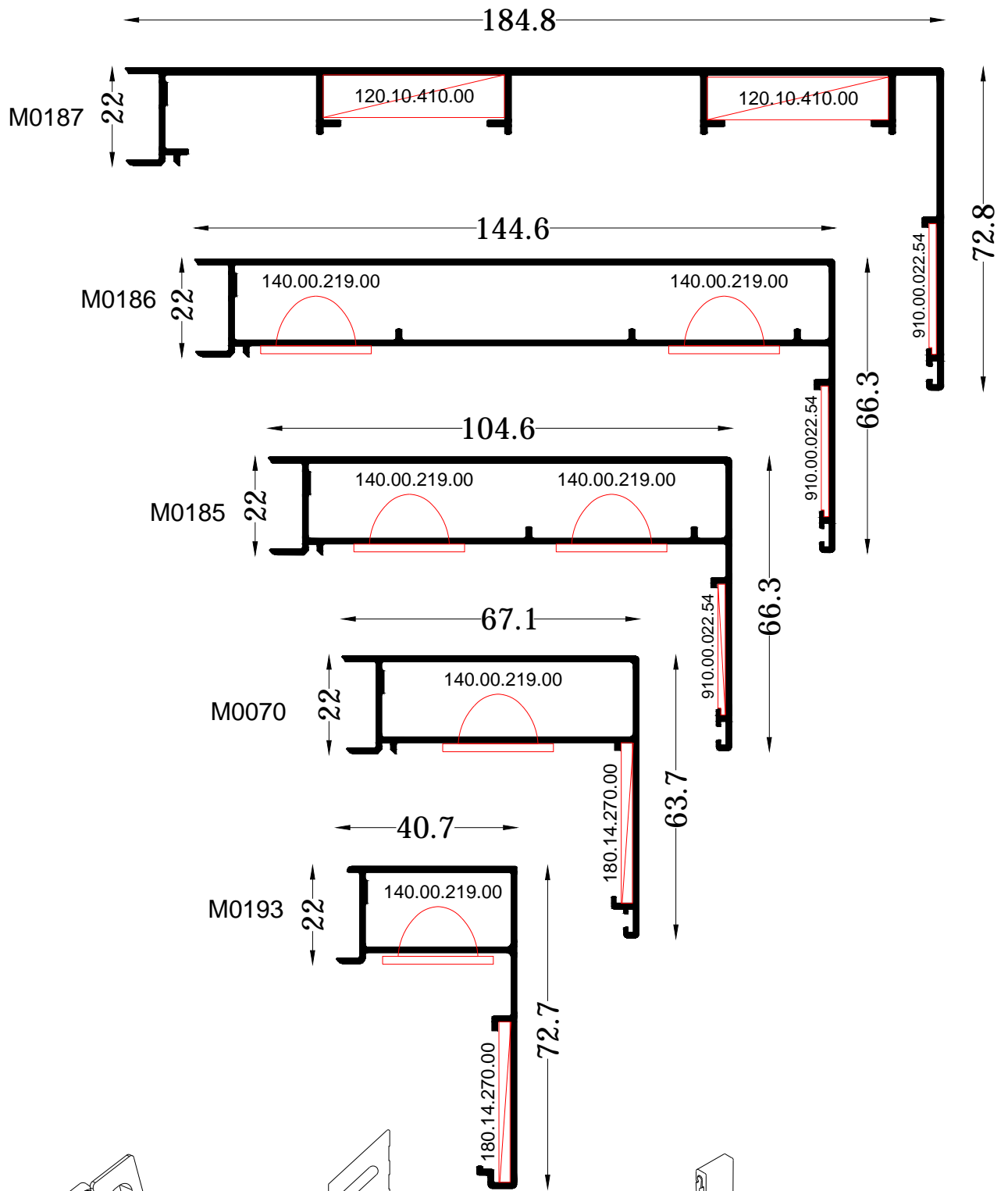

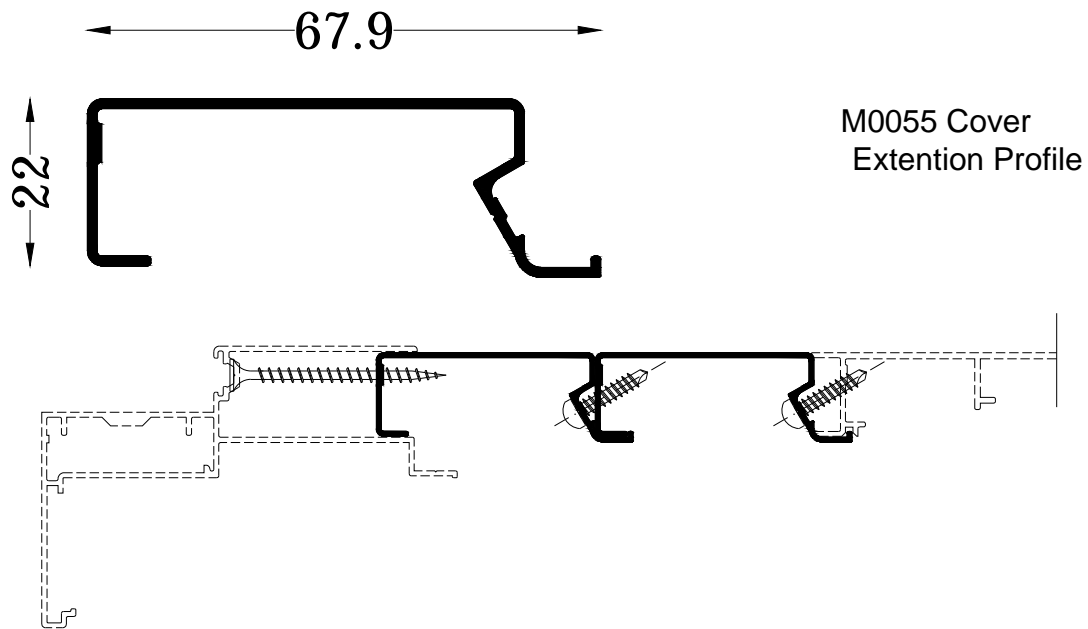

A. Wall thickness 70 to 105 mm

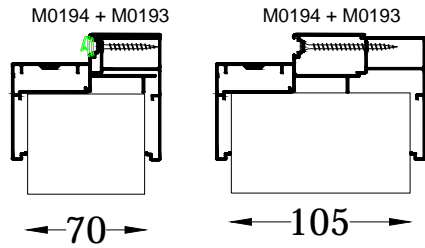

B. Wall thickness 105 to 145 mm

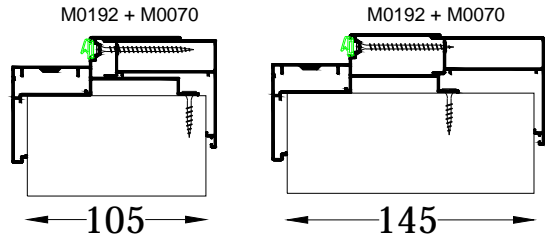

C. Wall thickness 146 to 185 mm

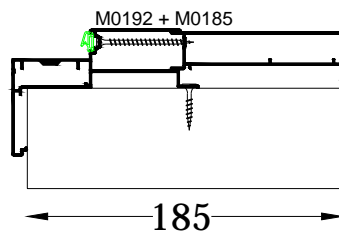
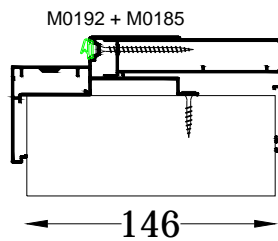

D. Wall thickness 186 to 225 mm

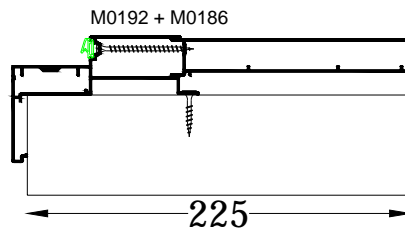
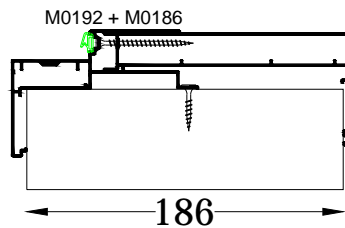

E. Wall thickness 226 to 265 mm

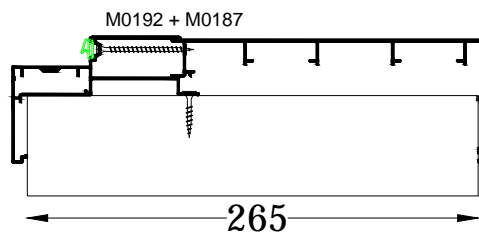
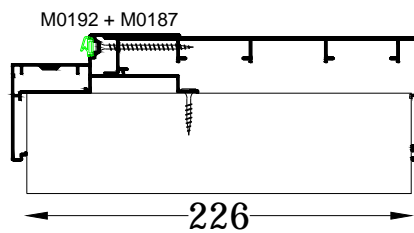

F. Wall thickness 280 ...

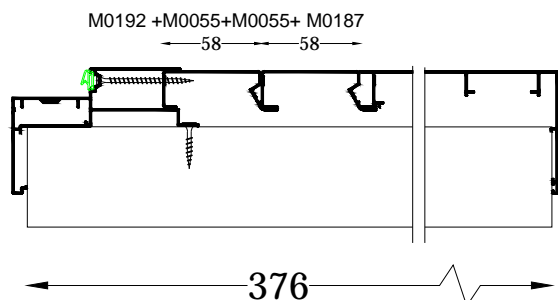
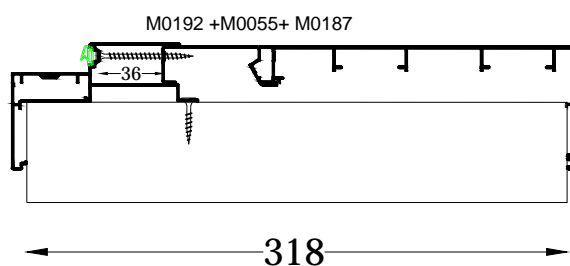

Linear Twin Door M0192 or M0194 + M0193

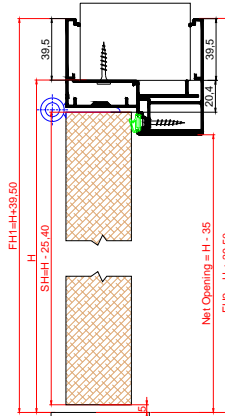
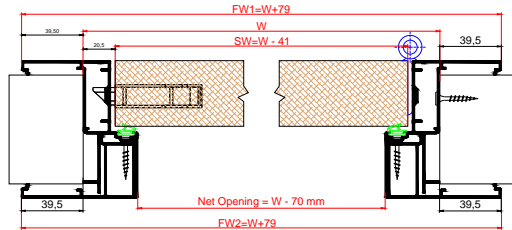

Linear Twin Door M0192 or M194 + M0070

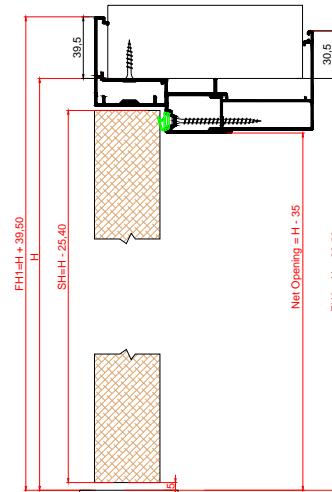
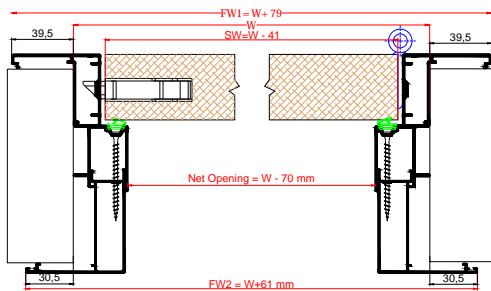

Linear Twin Door M0192 or M0194 + M0185

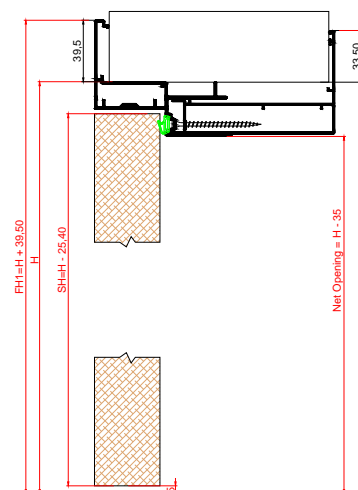
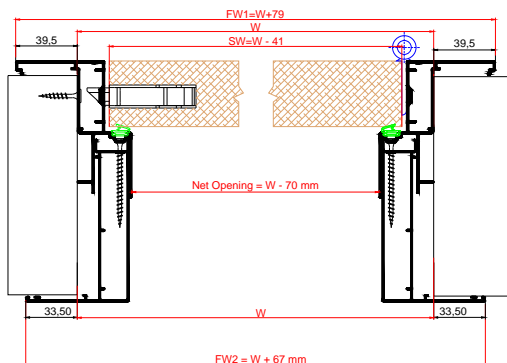



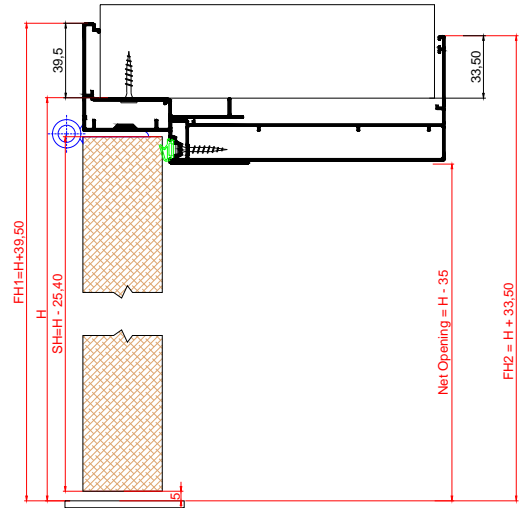
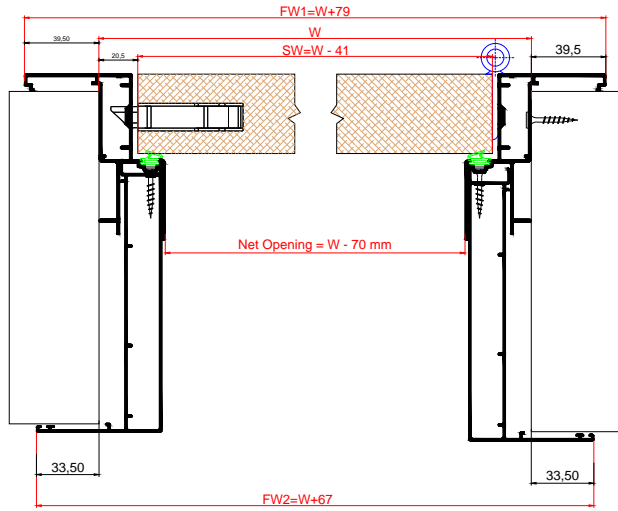

Linear Twin Door M0192 or M0194 + M0186

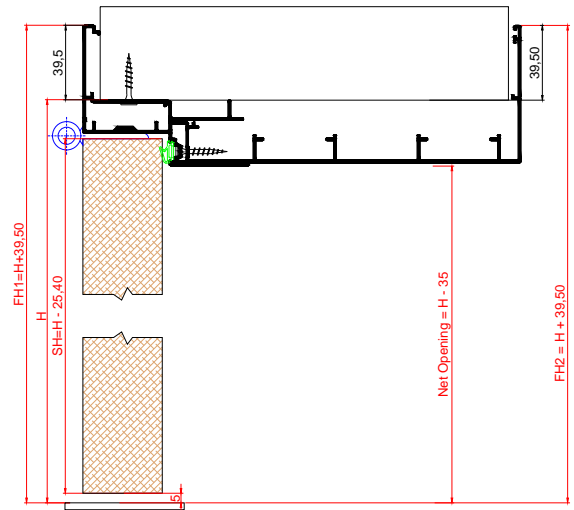
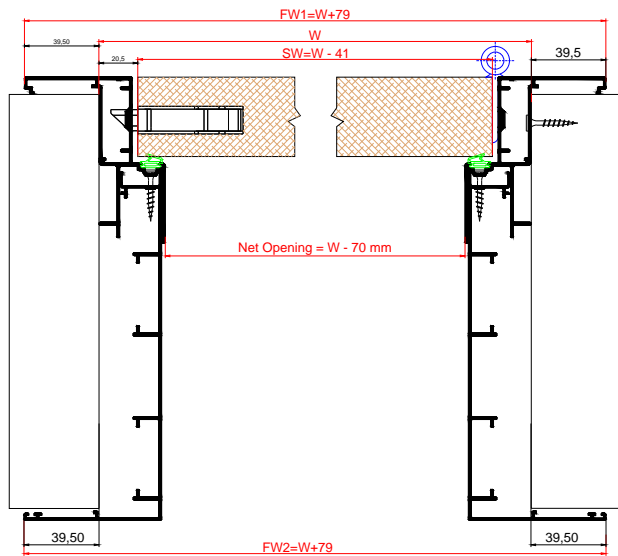



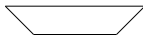
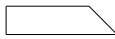

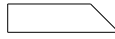
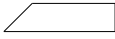

Linear Twin Door M0192 or M0194 + M0187

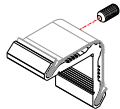

CUTTINGS

CODE			QUANTITY
Frame profile		According to pages nr. 'Linear05 and Linear06'	1 pcs
			1 pcs
			1 pcs
Cover profiles			1 pcs
			1 pcs
			1 pcs
Panel		1 pcs	

ACCESSORIES

DESCRIPTION	CODE		QUANTITY
Connection Corners for Frame profile	According Page 'Linear 01' <i>126.11.279.00</i>		2 PCS
Connection Corners for Cover profile	According Page 'Linear 02' <i>140.00.219.00</i>		2 PCS
Alignment Corners for the frame profile	According Page 'Linear 02' <i>180.14.270.00</i>		2 PCS
Frame gasket	<i>767.00.302.03</i>		2H+W
Magnetic Lock Striker for Magnetic Lock	440.40.961.00		1 pcs
	440.40.961.00		1 pcs
Simple Lock Striker inox	440.40.951.00		1 pcs
	440.40.912.00		1 pcs
Hinge	350.40.952.00		2 pcs

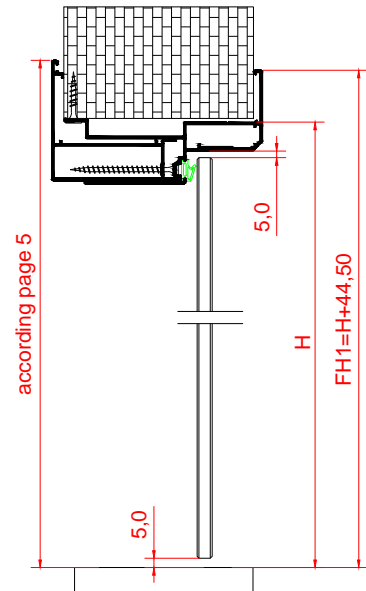
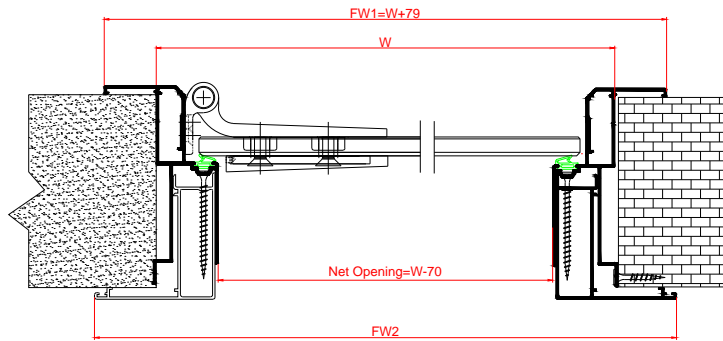

Glass Door Knop
Art. Nr. 455.40.970.00





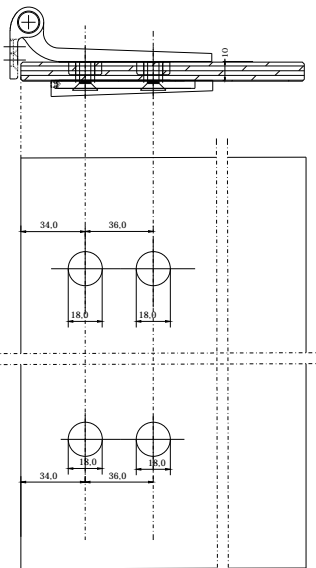

Glass Door Striker
Art. Nr. 455.40.971.00

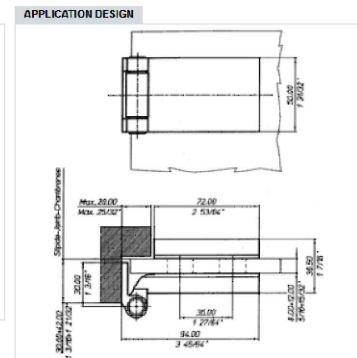
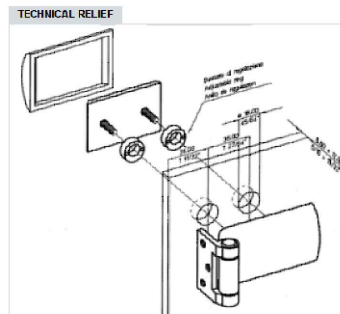



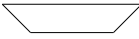
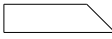

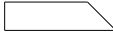
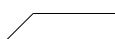



Hinge Millig & Positioning
Art. Nr. 350.40.956.00

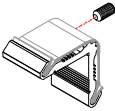

CUTTINGS

CODE			QUANTITY
Frame profile M0166		FW1 = W+79	1 pcs
		FH1 = H+44,50	1 pcs
		FH1 = H+44,50	1 pcs
Cover profiles		According to pages nr. 'Linear05 and Linear06'	1 pcs
			1 pcs
			1 pcs
Panel		Pw = W-44,50 Ph = H-27,30	1 pcs

ACCESSORIES

DESCRIPTION	CODE		QUANTITY
Connection Corners for Frame profile	According Page 'Linear 01' <i>126.11.279.00</i>		2 PCS
Connection Corners for Cover profile	According Page 'Linear 02' <i>140.00.219.00</i>		2 PCS
Alignment Corners for the frame profile	According Page 'Linear 02' <i>180.14.270.00</i>		2 PCS
Alignment Corners for the frame profile	<i>180.00.584.00</i>		2 PCS
Frame gasket	<i>767.00.302.03</i>		2H+W
Lock with Knop	<i>455.40.970.00</i>		1 pcs
Inox Striker	<i>455.40.971.00</i>		1 pcs
Hinge	<i>350.40.956.00</i>		2 pcs

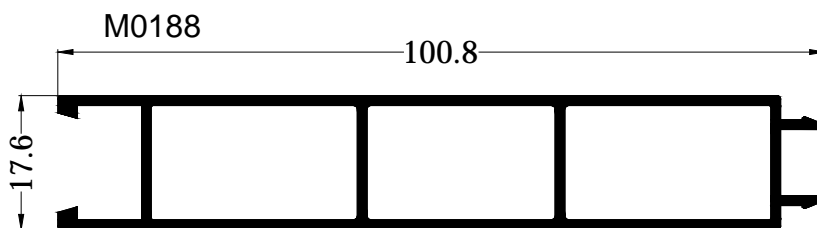
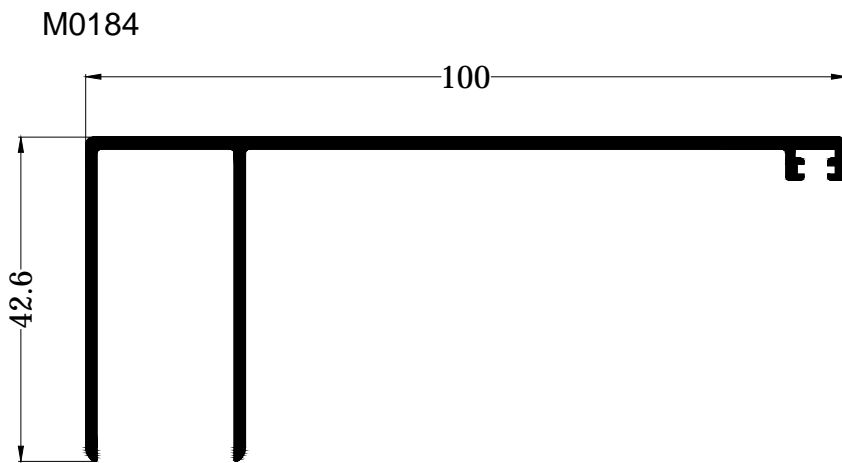
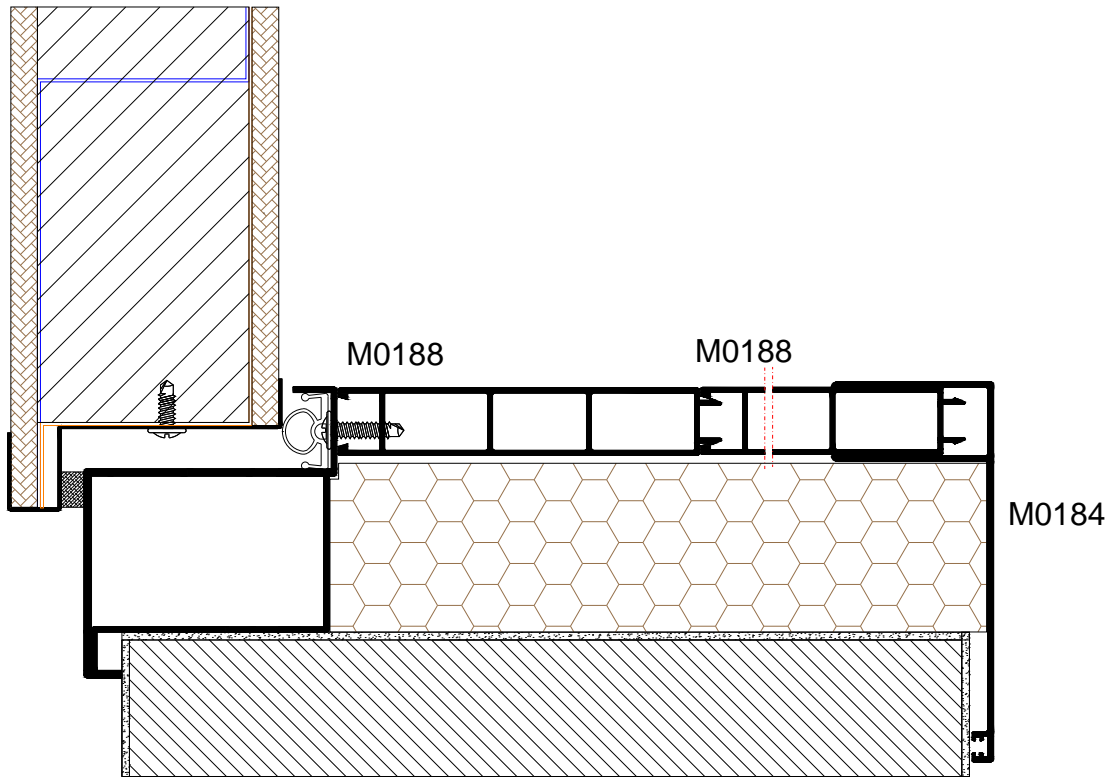

Exclusive Doors



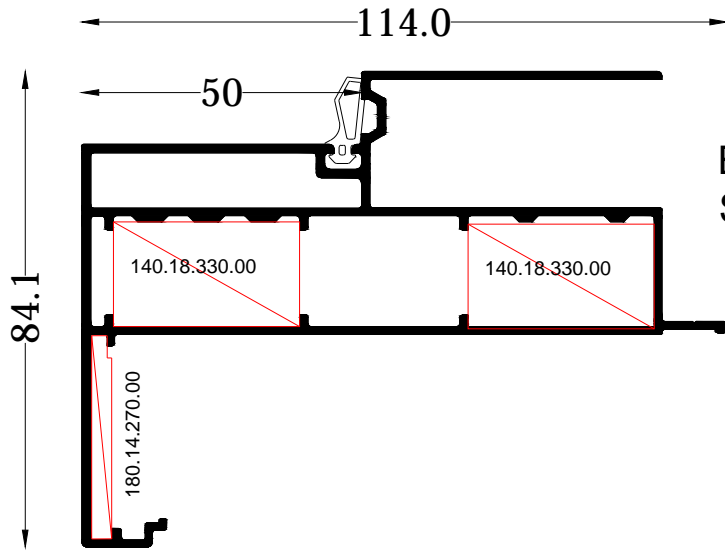

M0229 Frame for Exclusive Doors, Sashwidth 45mm

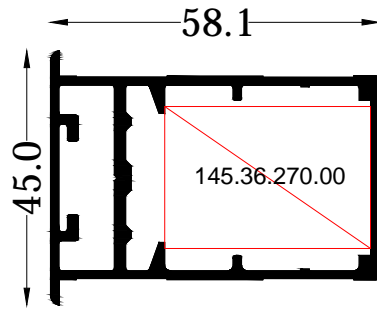

M0232 Leaf for Glasspanel

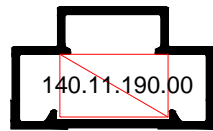

M0234 Spacer profile

Leaf for Wooden panel

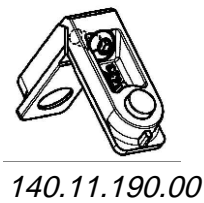
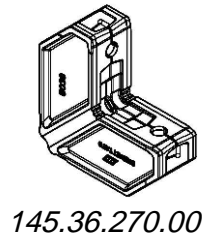
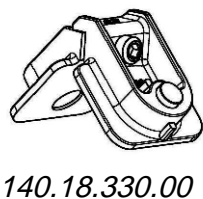
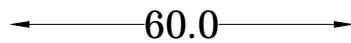
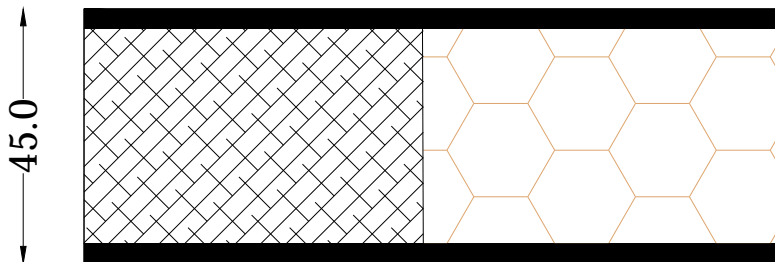

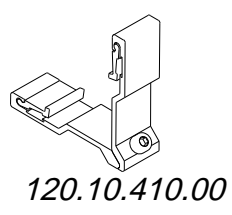
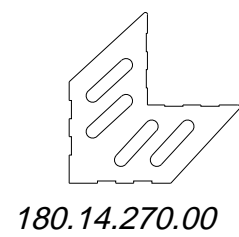
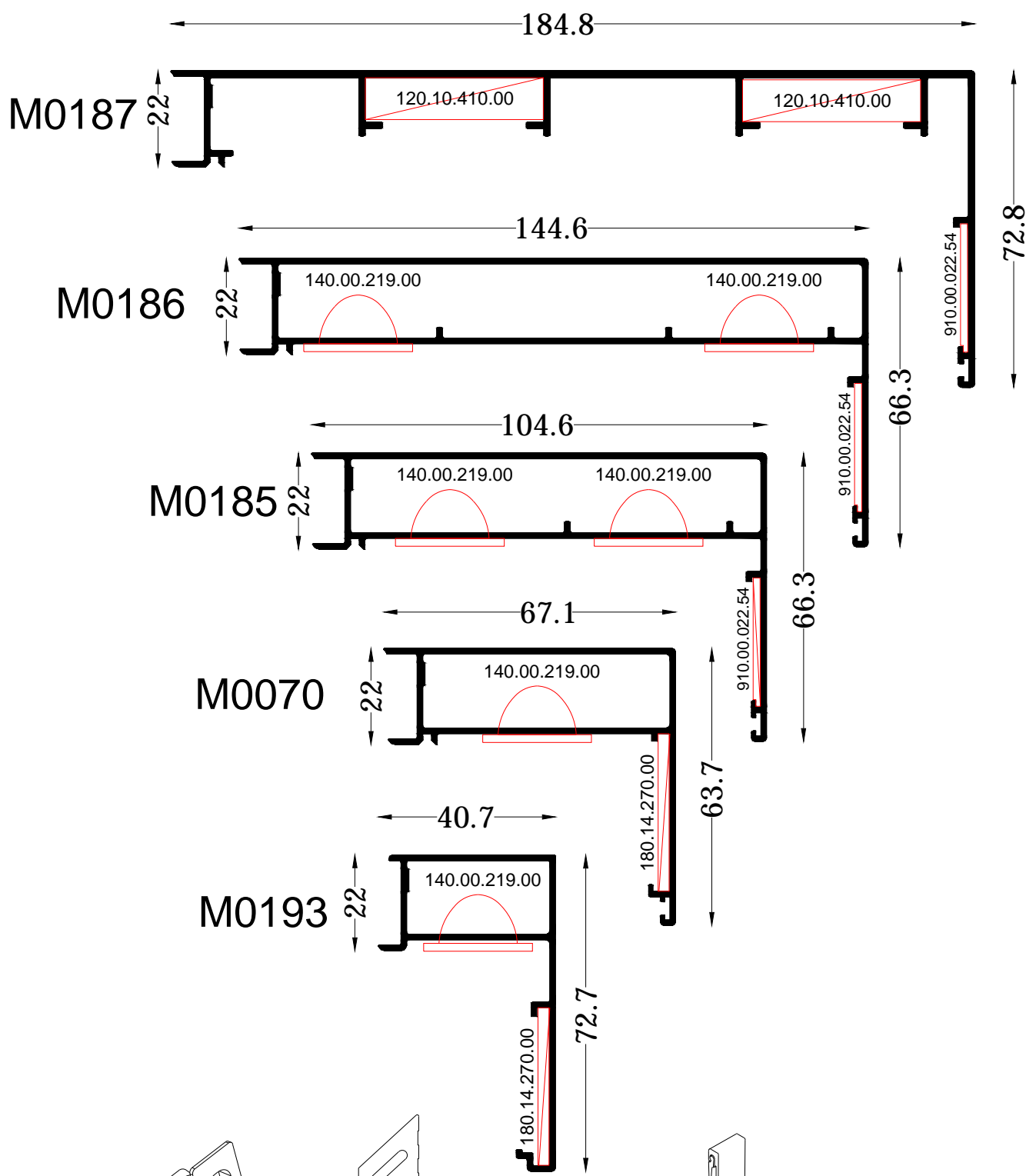

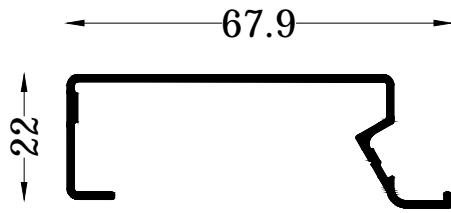

M0055 Cover
Extension Profile

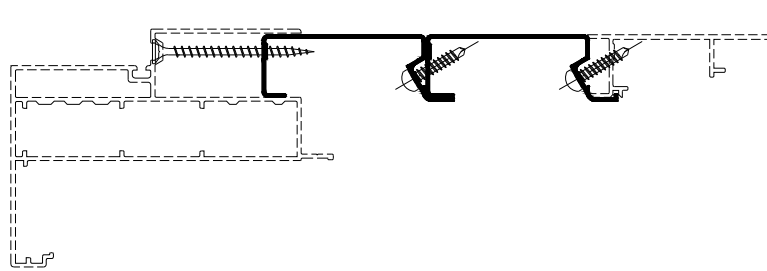

A. Wall thickness 100 to 110 mm

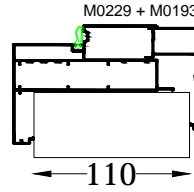
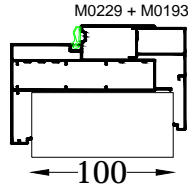

B. Wall thickness 110 to 140 mm

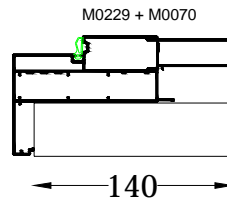
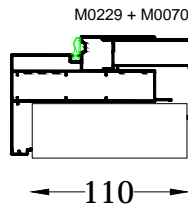

C. Wall thickness 140 to 180 mm

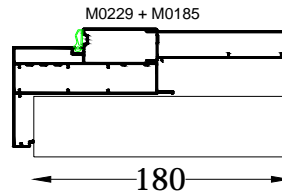
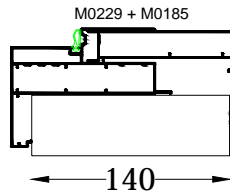

D. Wall thickness 180 to 220 mm

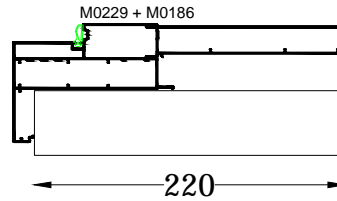
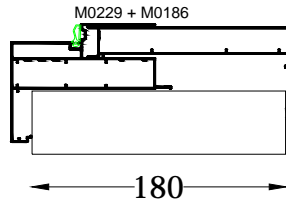

E. Wall thickness 220 to 250 mm

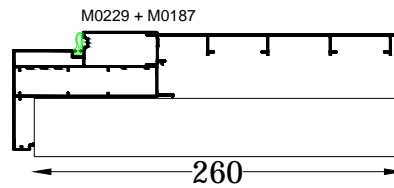
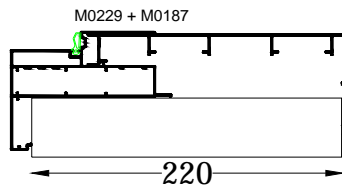

F. Wall thickness 280...

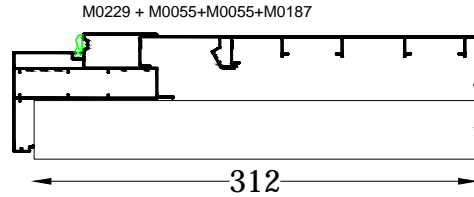
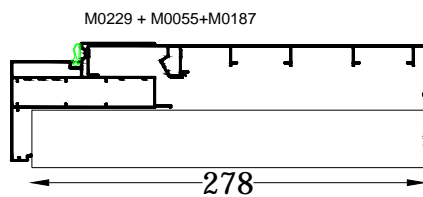

Exclusive Door with M0229 + M0193

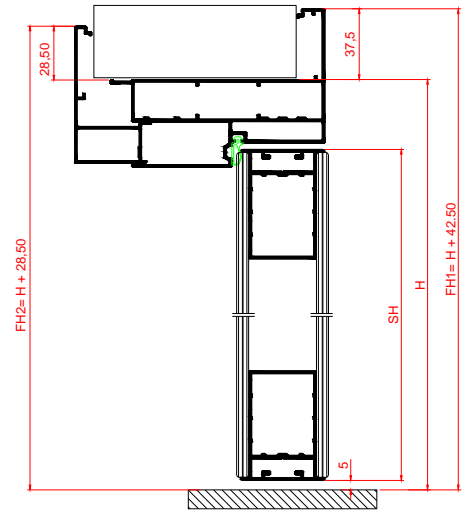
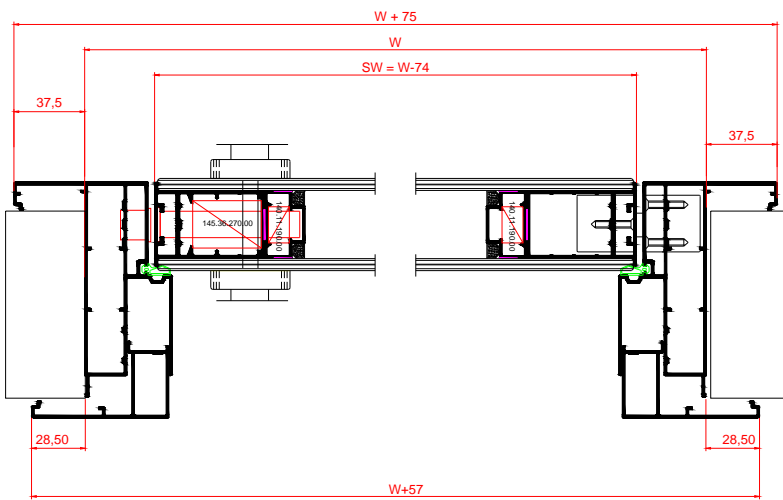

Exclusive Door with M0229 + M0070

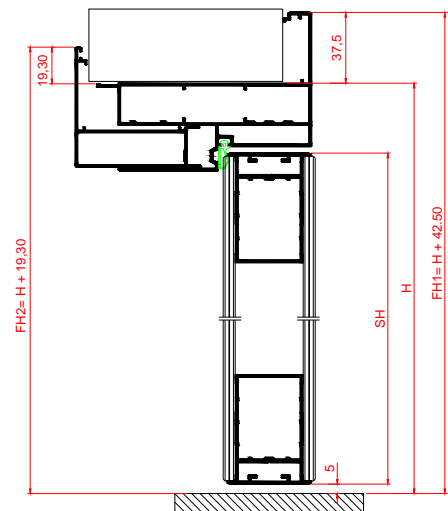
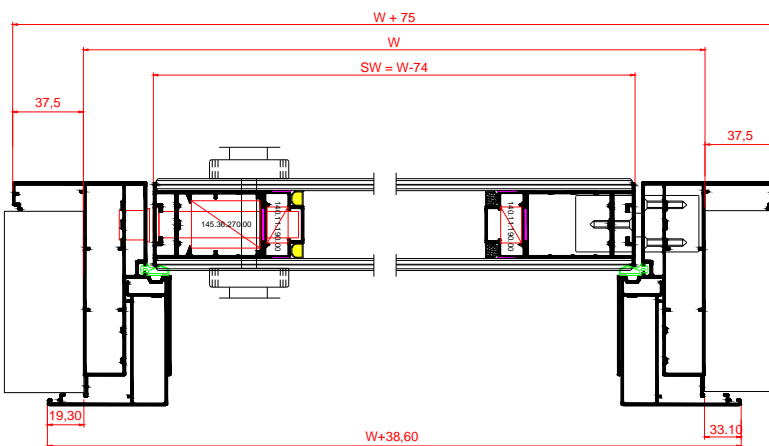

Exclusive Door with M0229 + M0185

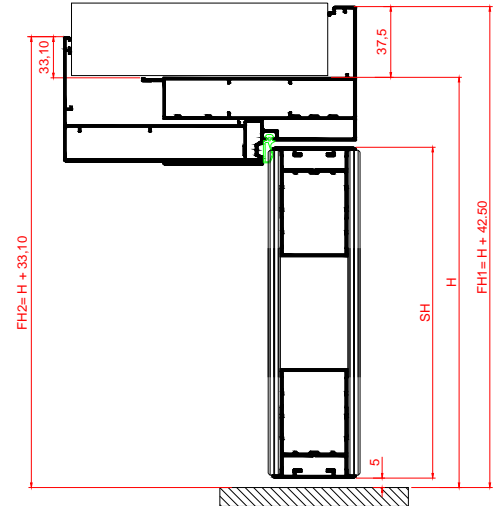
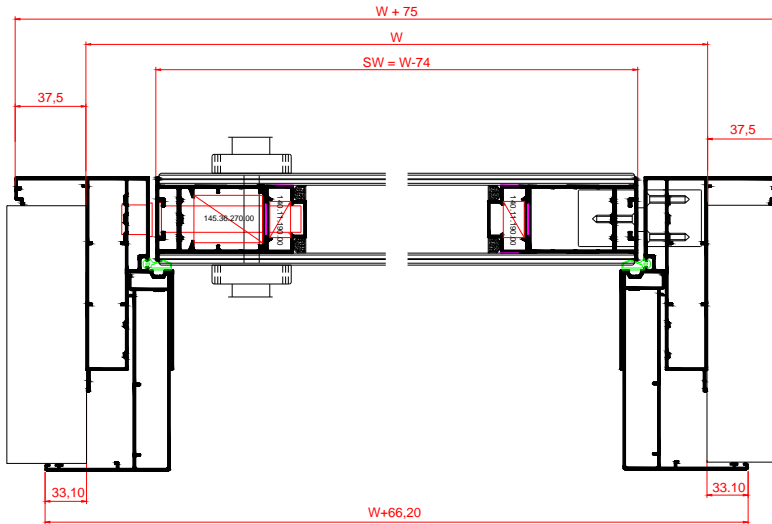



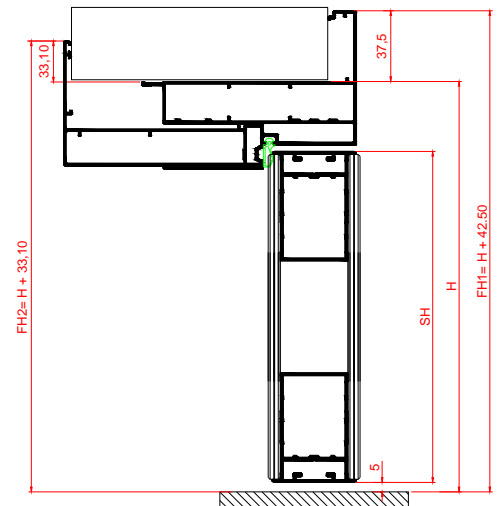
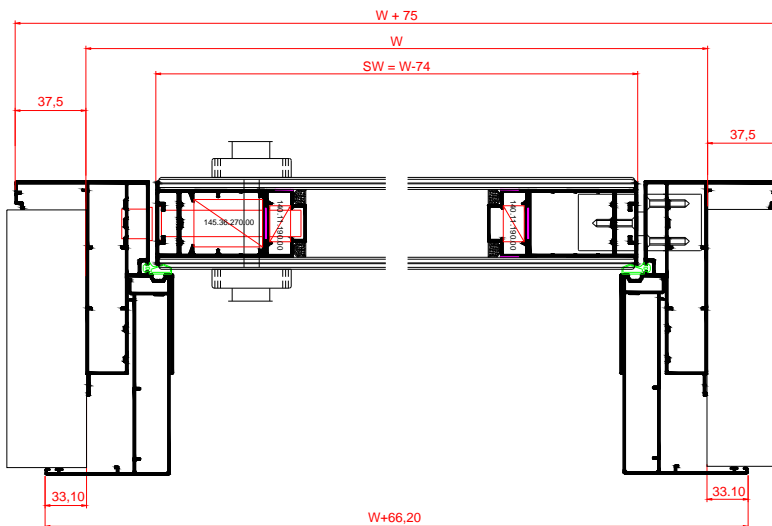

Exclusive Door with M0229 + M0186

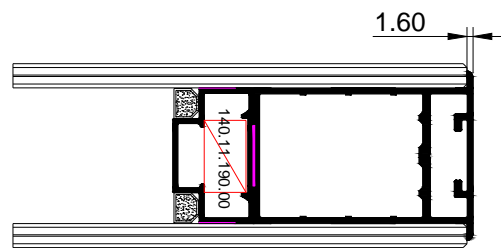
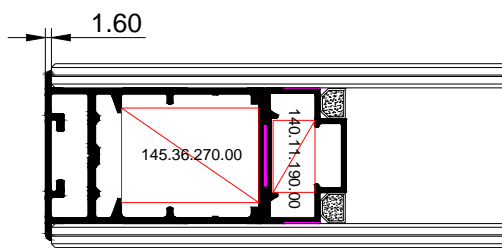
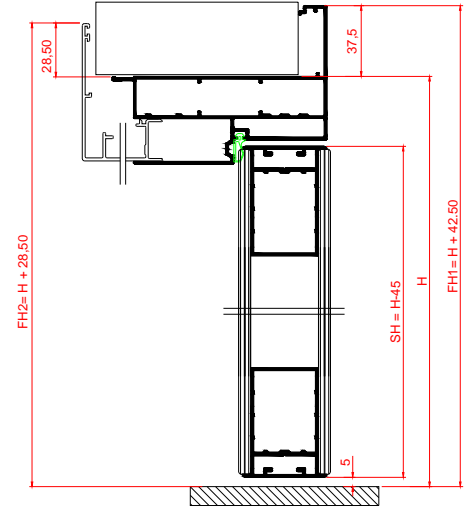
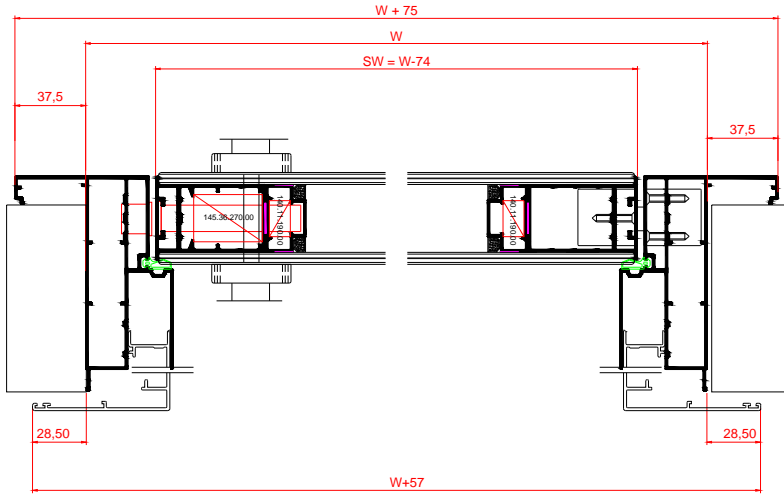





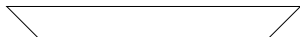

Exclusive Door with M0229 + M0187



CUTTINGS

CODE			QUANTITY
Frame profile M0229		W+75	1 pcs
		H+42,50	1 pcs
		H+42,50	1 pcs
Sash M0232		Sw = W-74mm	2 pcs
		SH= W-45mm	2 pcs
Panel	According pages 06 and 07		1 pcs

ACCESSORIES

DESCRIPTION	CODE		QUANTITY
Connection Corners for Frame profile	140.18.330.00		4 PCS
Connection Corners for Cover profile	145.36.270.00		4 PCS
Alignment Corner	180.14.270.00		2 PCS
SEAL GASKET	250.01.231.03		2H+W
MAGNETIC LOCK	440.40.960.00		1 PCS
Striker for Magnetic Lock	440.40.961.00		1 PCS
HINGE	350.40.949.00		2-4 PCS
HINGE CAPS	350.40.950.00		2-4 PCS

HINGE 350.40.949.00

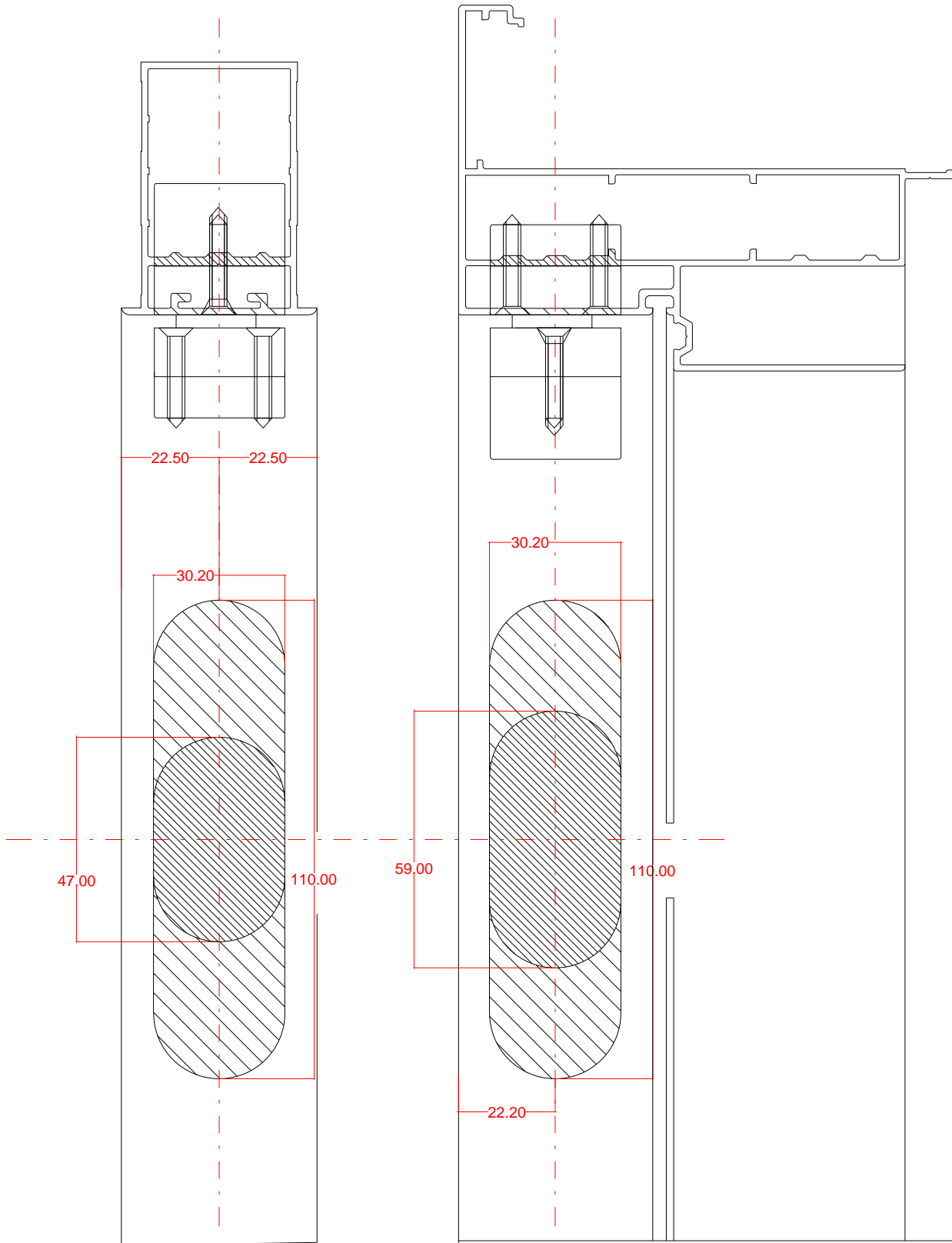

HINGE 350.40.955.00 Positioning

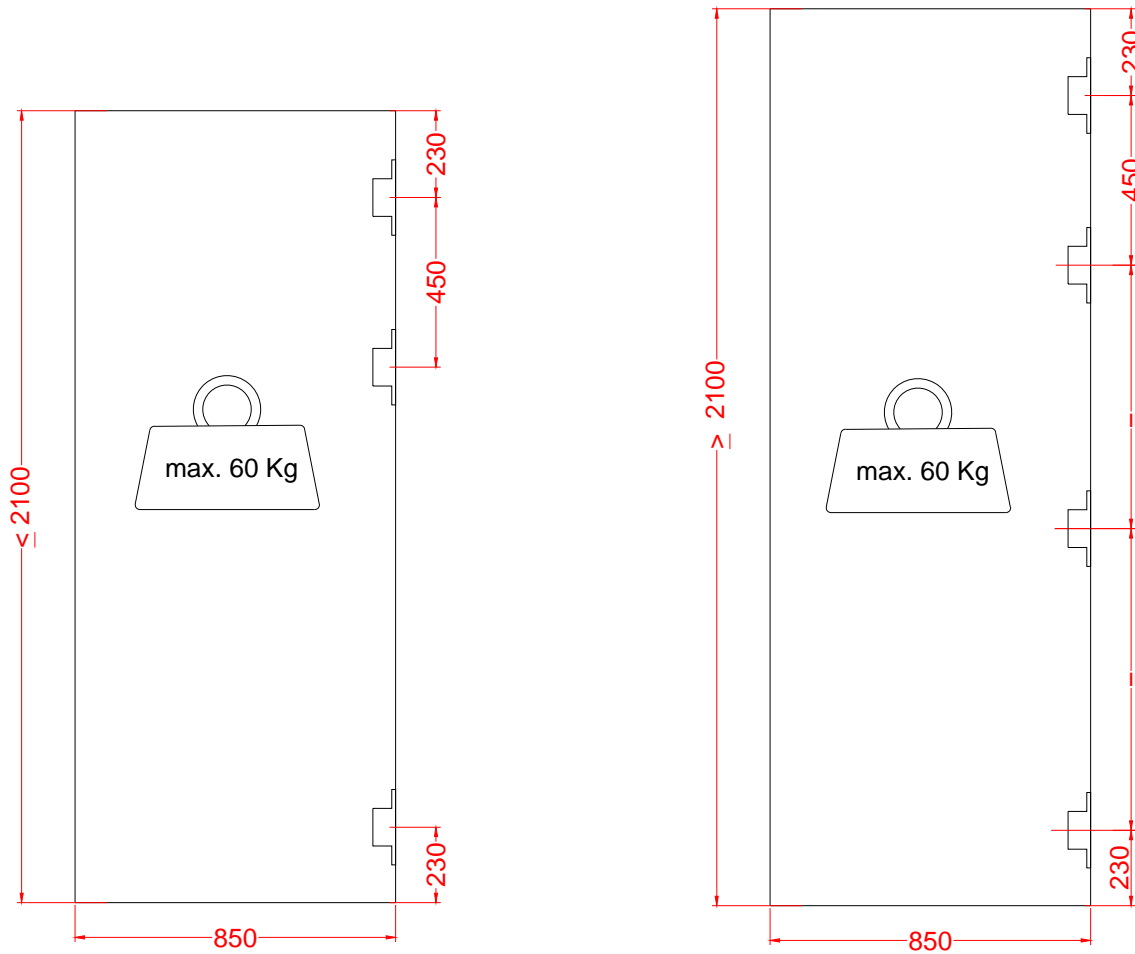

Milling

Striker 440.40.961.00

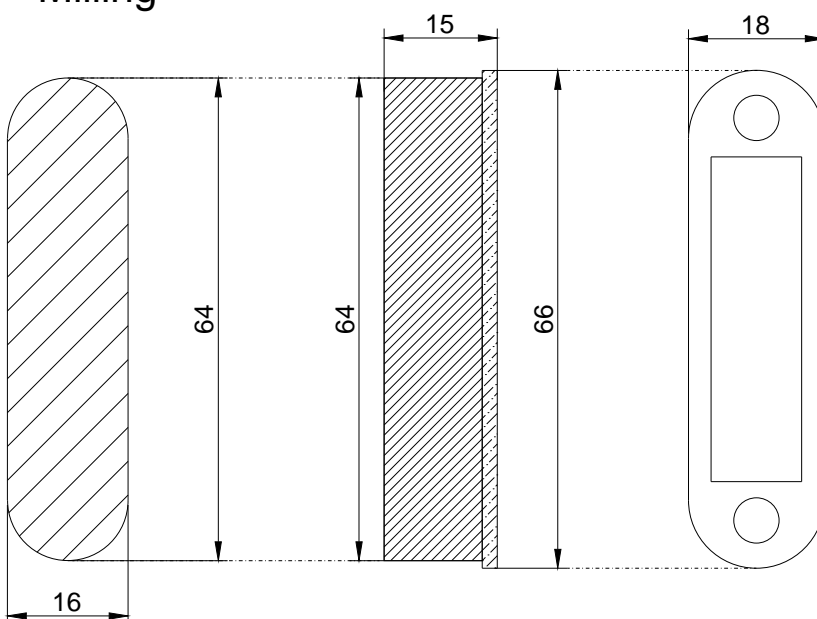

Suite Doors

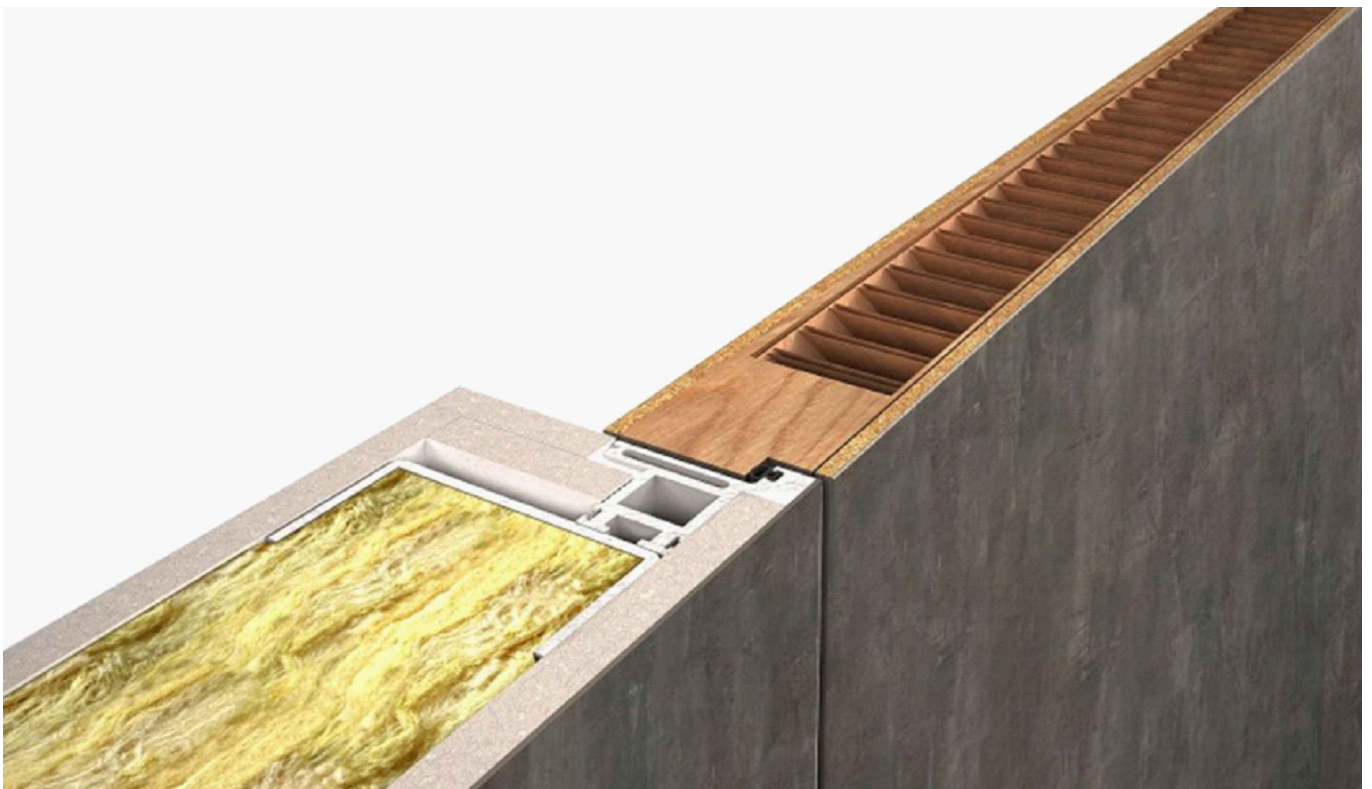

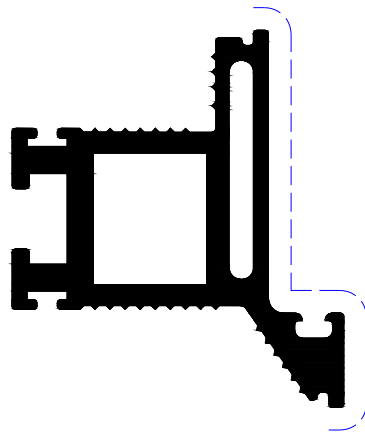

M0240 Frame profile

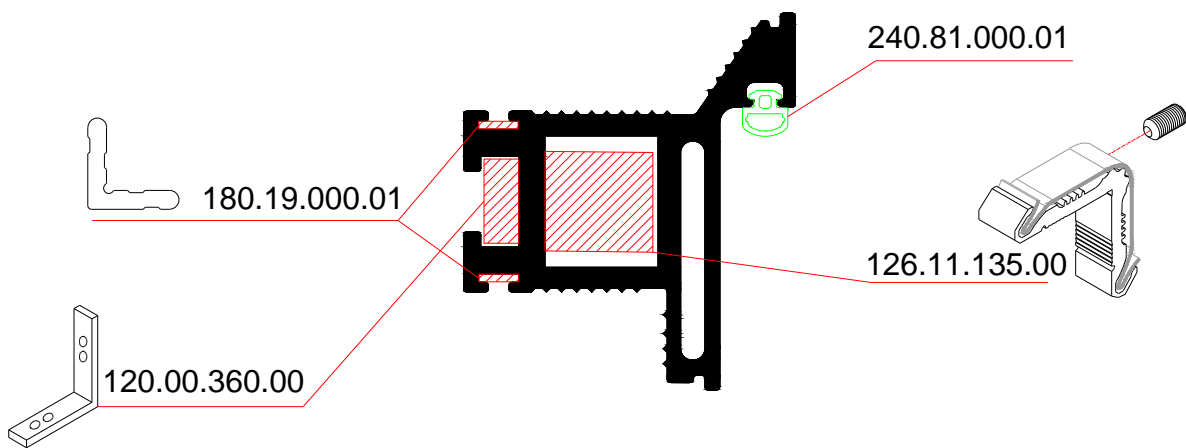



440.40.960.00

Magnetic Lock



440.40.961.00

Striker

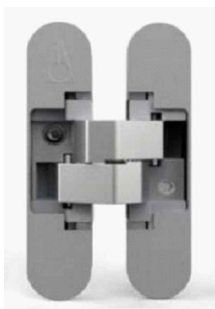

Hinge 350.40.955.00 quantity		
Height up to	Pcs	max. Weight
2200 mm	2 pcs	40 Kg
2500 mm	3 pcs	60 Kg
3000 mm	4 pcs	60 Kg

768.10.505.03 HINGE CAP

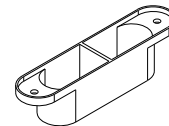

Door Installation

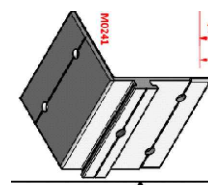
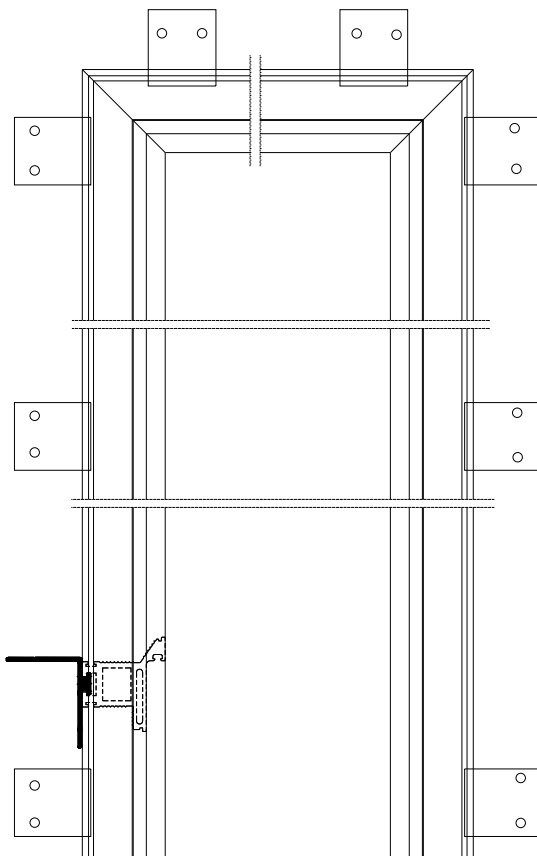

768.00.241.00
Wall mounting Corner

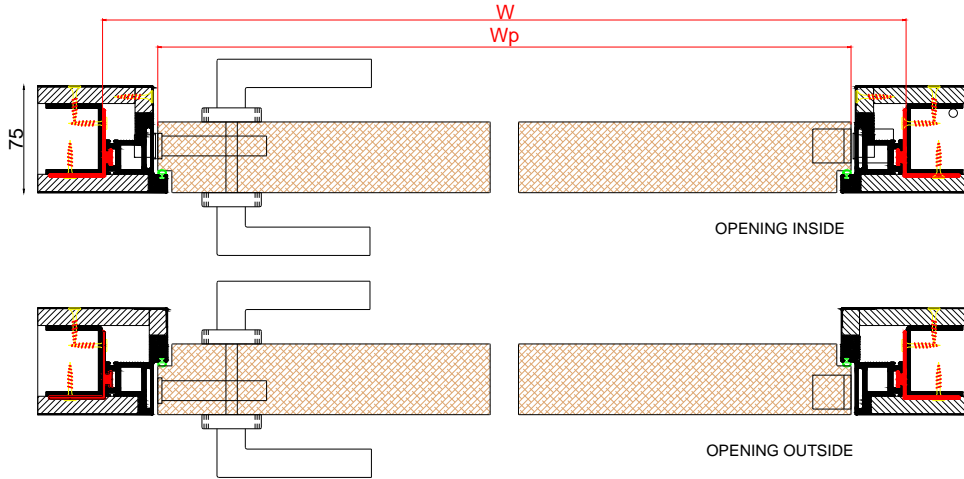



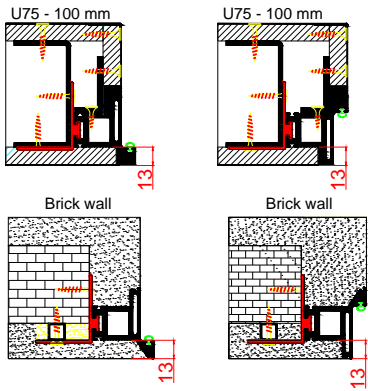



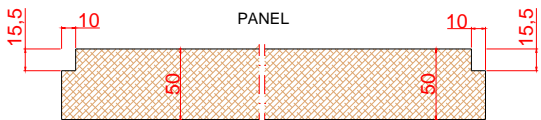
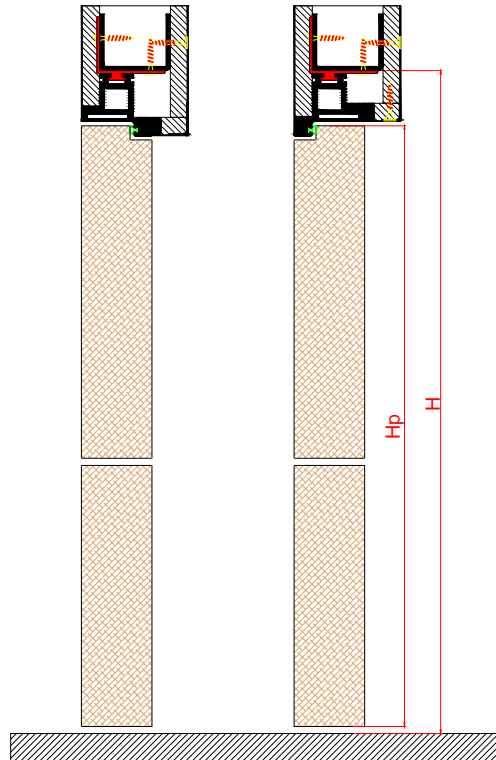

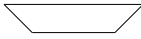

OPENING INSIDE OPENING OUTSIDE



OPENING INSIDE OPENING OUTSIDE

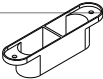

CUTTINGS			
CODE			QUANTITY
Frame profile M0240		W - 4	1 pcs
		H - 2	2 pcs
ACCESSORIES			
DESCRIPTION	CODE		QUANTITY
Connection Corner	120.11.135.00		2 PCS
Alignment Corner	180.19.000.01		4 PCS
Connection Corner	120.00.360.00		2 PCS
SEAL GASKET	240.81.000.01		2H+W
MAGNETIC LOCK	440.40.960.00		1 PCS
Striker for Magnetic Lock	440.40.961.00		1 PCS
HINGE	350.40.955.00		3 PCS
HINGE CAP	768.10.505.03		3 PCS
WALL MOUNTING CORNER	768.00.241.00		8 PCS

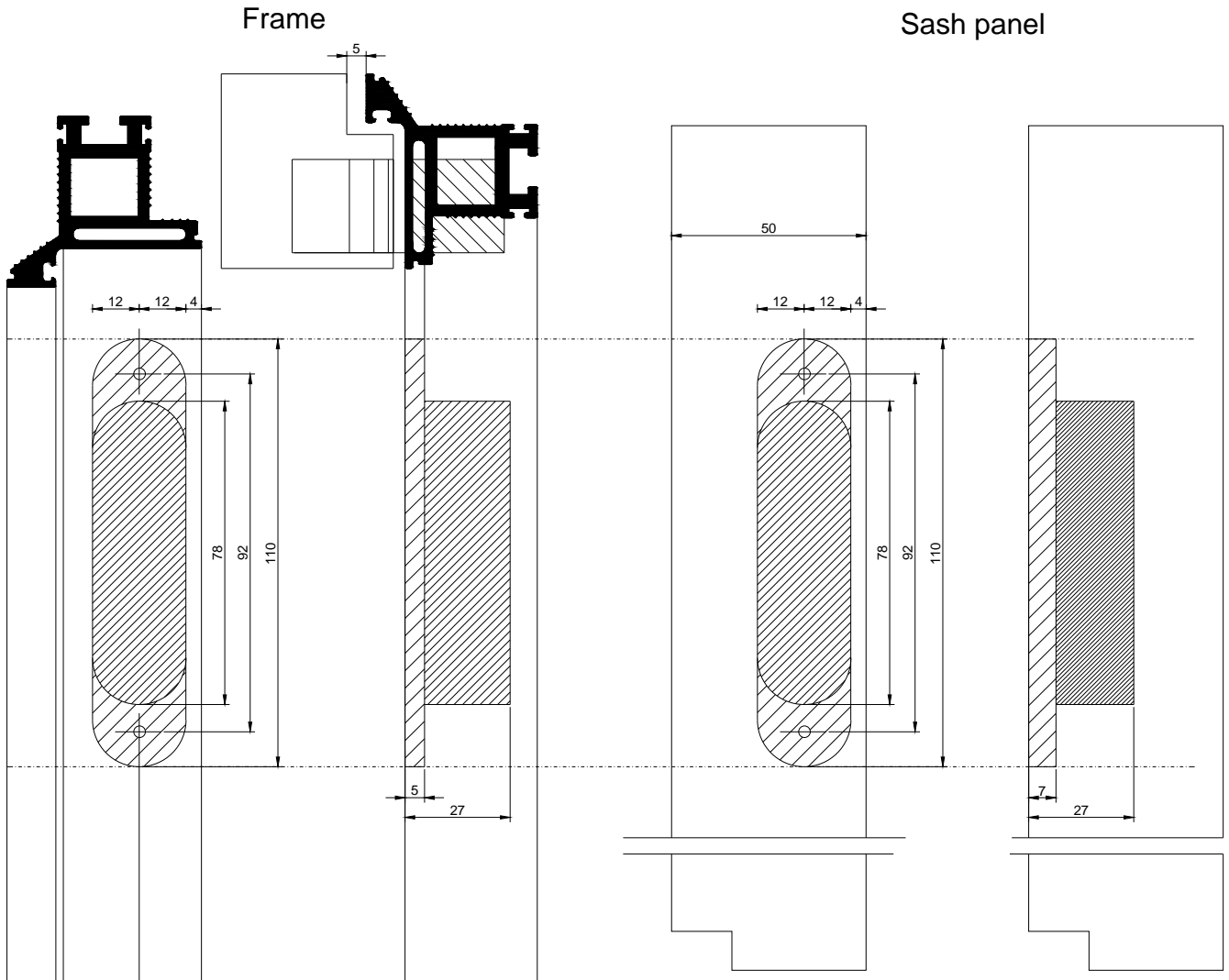

HINGE 350.40.955.00

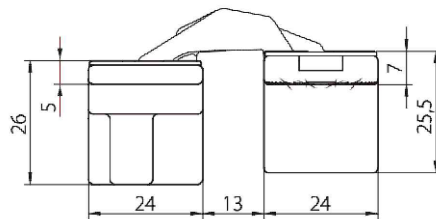
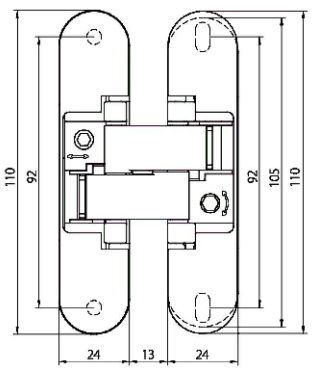

768.10.505.03 HINGE MOUND

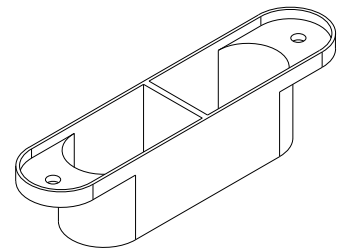

HINGE 350.40.955.00 Positioning

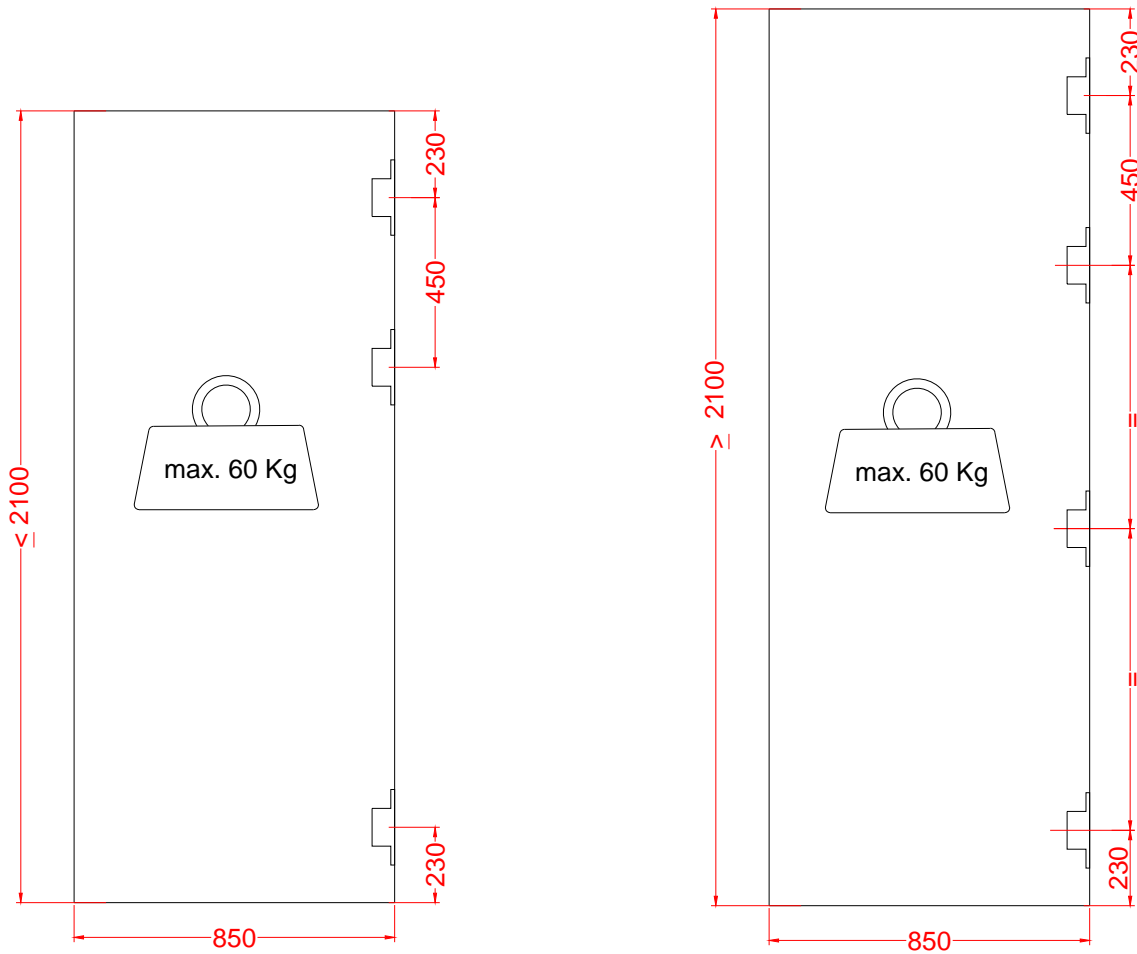



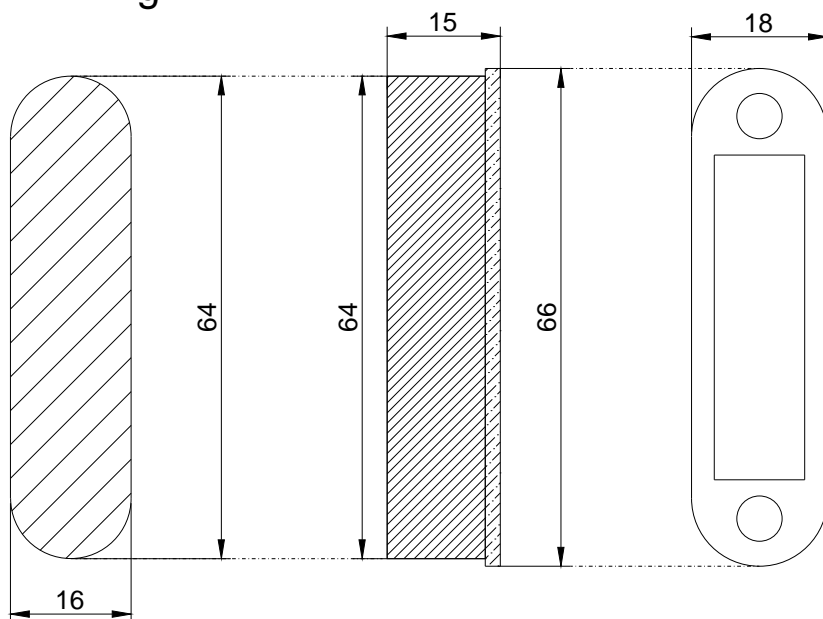



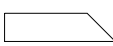
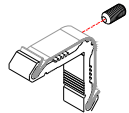

Milling

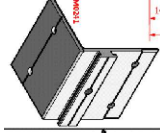

Striker 440.40.961.00



CUTTINGS			
CODE			QUANTITY
Frame profile M0240		W - 4	1 pcs
			
		H - 2	2 pcs
ACCESSORIES			
DESCRIPTION	CODE		QUANTITY
Connection Corner	120.11.135.00		2 PCS
Alignment Corner	180.19.000.01		4 PCS
Connection Corner	120.00.360.00		2 PCS
SEAL GASKET	240.81.000.01		2H+W
WALL MOUNTING CORNER	768.00.241.00		8 PCS
HINGES	350.40.956.00		2 PCS
DOOR KNOP	455.40.970.00		1 PCS
STRIKE PLATE	455.40.971.00		1 PCS

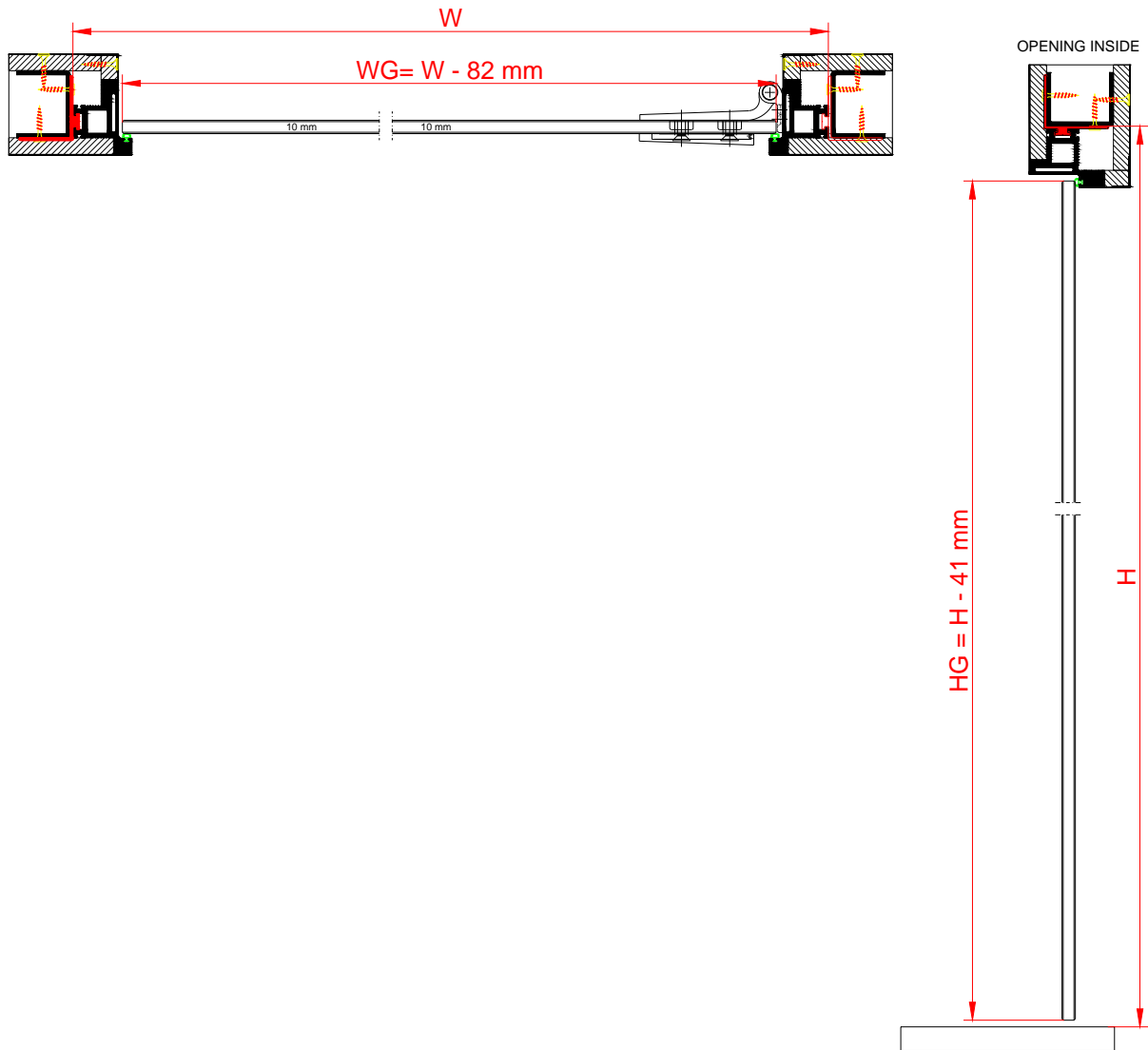

Hinge Millig & Positioning
Art. Nr. 350.40.956.00

